

# SENSORS DAY 2022

## Sensors in an Uncertain World

Weds 12<sup>th</sup> October 2022  
Møller Institute Cambridge



Sensors Day is an annual conference organised by the EPSRC Sensor CDT showcasing highlights of sensor research and applications from all areas of science and technology. This year our diverse field of speakers will present on sustainability, healthcare, ethics, and citizen science.

For further information and to register, please visit:  
<https://cdt.sensors.cam.ac.uk/events/sensors-day-2022>



## Contents

Schedule.....	3
<b>Session 1: Perspectives on uncertainty</b> .....	3
<b>Session 2: Student showcase</b> .....	3
<b>Session 3: Uncertain data from sensors for healthcare and the environment</b> .....	4
Keynote speaker abstracts.....	5
Prof. Mauro Guillén.....	5
Dr. Will Gompertz .....	6
Dr. Richard Milne .....	7
Dr. Cian O’Donovan .....	8
Lorena Qendro .....	9
Dr. Maurizio Bevilacqua .....	10
Dr. Simon Tilley .....	11
Dr. John Kupiec .....	12
Student talk abstracts .....	13
Towards Uncertainty-Aware Murmur Detection in Heart Sounds via Tandem Learning.....	13
Structural Mass Spectrometry Techniques for Investigating Therapeutic Peptides .....	14
Sensor Measurement Uncertainty and Ways to Reduce it.....	15
Optofluidic Hollow-Core Photonic Crystal Fibres as Label-Free Biophysical Sensors.....	16
Intracellular A $\beta$ 42 aggregation leads to cellular thermogenesis .....	17
Interactions between alpha-synuclein and lipid membranes in Parkinson’s disease .....	18
Studying Organic Electrochemical Transistors for Applications in Neuroscience Diagnostics .....	19
About the Sensors CDT .....	20
Sponsors.....	21

## Schedule

9:00	<b>Welcome and Introduction</b> - Prof. Clemens Kaminski
<b>Session 1: Perspectives on uncertainty</b>	
09:05	<b>Global Market Trends to 2030 and Beyond</b> Prof. Mauro Guillen, Dean, Judge Business School, Cambridge University
09.35	<b>Tomorrow's Engineering Research Challenges</b> Dr. Will Gompertz, Portfolio Manager, EPSRC
10:00	<b>Science, uncertainty and the public</b> Dr. Richard Milne, Deputy Director, Kavli Centre for Science, Ethics and the Public
10:25	<b>Empowering infrastructures</b> Dr. Cian O'Donovan, Senior Research Fellow, Science & Technology Studies, UCL
<b>Session 2: Student showcase</b>	
10:50	Break, networking and poster exhibition <i>Hallway and Study Centre 8</i>
11:20	<b>Cyanovision: a low-cost, open-source early-warning system for cyanobacteria in freshwater</b> Sensors CDT Team Challenge 2022
12:00	Lunch
13:00	<b>Student Talks</b>
14:15	Break, networking, poster exhibition <i>Hallway and Study Centre 8</i>

**Session 3: Uncertain data from sensors for healthcare and the environment**

14:45 **Can you trust your model's prediction? Building uncertainty aware mobile sensing application**

Lorena Qendro, Senior AI Researcher, Nokia Bell Labs

15:10 **The Data challenges: NPL's use cases on sensor data analysis, visualization, and validation**

Dr. Maurizio Bevilacqua, Senior Research Scientist, Data Science Department, National Physical Laboratory

15:40 **Seeing is believing**

Dr. Simon Tilley, SAS Healthcare

16:05 **Environment Agency - Sensors: Applications, Developments and Challenges**

Dr. John Kupiec, Innovation Manager, Environment Agency

16:50 **Student Prizes and Closing- Prof. Roisin Owens**

Sponsored by [Zimmer& Peacock](#)

17:00 End of Day, Group Photo

## Keynote speaker abstracts

Prof. Mauro Guillén

### **Global Market Trends to 2030 and Beyond**

Dean Mauro Guillen will present an interactive lecture on “Global Market Trends to 2030 and Beyond.” He will discuss that Africa will be the second-biggest region by population, India will have a bigger consumer market than China, the population above the age of 60 will be the market segment with the greatest purchasing power, more than half of the world’s wealth will be owned by women, and there will be more robots than human beings. What are the implications for the economy, for companies, and for consumers? What role will technology play in shaping those demographic and economic trends. Learn about the largest growth opportunities in global markets and how they will reshape the future.

---



Mauro F. Guillén is President-elect of the Princess of Asturias Foundation, Dean and Professor of Management Studies at the Judge Business School of the University of Cambridge, and Professor Emeritus of Management and Sociology at the Wharton School of the University of Pennsylvania, where he served for 12 years as Director of the Joseph H. Lauder Institute of Management and International Studies. He holds a PhD in Sociology from Yale University and a doctorate in Economic and Business Sciences from the University of Oviedo. His scholarly research deals with globalization, geopolitics, multinational corporations, digital platforms, and modernist architecture as an artistic movement. He is the author of a dozen books translated into 17 languages. His online courses have attracted over 100,000 participants.

He has received Fulbright, Rockefeller, and Guggenheim fellowships, and research prizes from the Academy of Management, the American Sociological Association, the Social Science History Association, and the Gustavus Myers Center for the Study of Bigotry and Human Rights. He is a member of the Institute for Advanced Study in Princeton and an elected member of the Sociological Research Association and the Macro Organizational Behavior Society, and a winner of the Aspen Institute’s Faculty Pioneer Award.

---

Website: <https://www.jbs.cam.ac.uk/faculty-research/faculty-a-z/mauro-guillen/>

Dr. Will Gompertz

### Tomorrow's Engineering Research Challenges

Will Gompertz, Portfolio Manager for Sensors & Instrumentation and Microsystems at EPSRC, will present an overview of EPSRC's latest delivery plan and the [Tomorrow's Engineering Research Challenges Report](#)<sup>1</sup>.

The Tomorrow's Engineering Research Challenges consultation in particular, presents an exciting set of cross-cutting themes, technological challenges, high-level priorities that have been developed with endorsement from members across the research and development community: from PhD students, to academia and industry to professional institutions. Will will ask conference attendees to think about how the future of sensors research can fit into these various priorities.



---

Will has worked at EPSRC for just over a year, looking after the Sensors & Instrumentation and Microsystems portfolios, fellowships for the Engineering Theme, and leading on EPSRC's systems thinking strategy.

Before EPSRC, Will studied Engineering Design (MEng) at the University of Bristol with interest and specialisation in decarbonising the energy sector, vertical farming, and structural engineering. Will has also worked at Frazer-Nash Consultancy as a structural certification engineer, with experience in the aviation, nuclear and defence sectors.

---

LinkedIn: <https://uk.linkedin.com/in/will-gompertz-793831138>

---

<sup>1</sup> <https://www.ukri.org/publications/tomorrows-engineering-research-challenges/>

Dr. Richard Milne

### **Science, uncertainty and the public**

In this talk, he introduces the work of the Kavli Centre for Ethics, Science and the Public, focusing on public understanding of, and engagement with, societal and ethical uncertainties associated with scientific advance. Richard focuses specifically on research exploring the social and ethical challenges associated with the use of ubiquitous digital devices in the detection of cognitive decline, particularly related to the collection and processing of data derived from both active and passive sources of data, and how these are affected by specific domains of application.



---

Richard is a sociologist of science, technology and medicine. He is the Deputy Director of the Kavli Centre for Ethics, Science, and the Public at the University of Cambridge and Head of Research and Dialogue at Wellcome Connecting Science. Richard's interests are in the interface between science and the public, particularly around how scientists and members of the public engage with controversial scientific topics and the possible futures created by new science and technology. This includes a focus on the social and ethical challenges associated with scientific advance - something that he has explored in relation to biotechnology, ageing and dementia, and latterly genomics, big data and medical applications of artificial intelligence. His research, drawing on qualitative, ethnographic and quantitative approaches, has been published widely in both social science and biomedical journals, reflecting a commitment to engaging with interdisciplinary audiences.

---

Website: <https://societyandethicsresearch.wellcomeconnectingscience.org/staff/richard-milne>

Website: [Kavli Centre for Ethics, Science, and the Public \(kcesp.ac.uk\)](https://www.kcesp.ac.uk)

Dr.Cian O'Donovan

### **Empowering infrastructures**

Following COVID-19, digital transformation agendas are driving change in health and social care infrastructures in the United Kingdom and beyond. Sensor technologies – along with accompanying data processes, practices and products – are being deployed at pace, often in settings such as care homes that have long been neglected in innovation policy. But without attention to context and careful configuration, digital infrastructures risk increasing uncertainty and diminishing wellbeing for staff, residents, patients and their families.

In this talk I will reflect briefly on how the marriage of uncertainty, risk and technological change is an inescapable feature of modern life. I will then draw on recent research that has investigated digital technologies inside UK housing schemes for older people and amongst health and social care workforces. This will show how digital infrastructures actively shape the identities and capabilities of users.

This has important implications for the ongoing development of sensor technologies as well as the capacity building required of our science, technology, and engineering CDTs. Capacity, for instance, to develop and sustain interdisciplinary capabilities and networks required to ensure that technologies are ready for society, and will ultimately empower users and not exclude them.



---

Dr. Cian O'Donovan is an expert in the governance of innovation, especially digital transformations in long term care. He is a Senior Research Fellow at UCL's Department of Science and Technology Studies. He uses social science research on technologies of care to study who benefits from innovation more broadly, who pays for it, and who decides.

---

Website: <https://www.ucl.ac.uk/sts/people/dr-cian-odonovan>

Twitter: [@cian](#)



Lorena Qendro

**Can you trust your model's prediction? Building uncertainty aware mobile sensing applications.**

Deep learning is increasingly adopted for decision-making in many safety-critical tasks. However, commonly used deep learning models are deterministic and unable to provide any estimate of predictive uncertainty. Uncertainty quantification is critical since the input distributions are often shifted from the training distribution due to different hardware and data collection protocols. Additionally, uncertainty aware approaches can help decide when a human-in-the-loop is necessary to complement the system or balance the computation in a distributed multi-tier (cloud) architecture in case of uncertainty. Current methods, however, are often resource-agnostic and unfeasible in real-world scenarios. In this talk, I will first introduce the different types of uncertainties stemming from sensor data and model parameters. Further, I will present my research efforts towards investigating different techniques to efficiently and accurately enable uncertainty aware mobile sensing applications and how to apply them to provide robustness against distributional shifts and adversarial attacks, and other settings.

---



Lorena is a Senior AI Researcher at Nokia Bell Labs working on topics involving Continual Learning, On-Device ML, and Federated Learning. She did her Ph.D. in Computer Science at the University of Cambridge, working with Prof. Cecilia Mascolo. Her Ph.D. research aimed at investigating different techniques to efficiently and accurately provide uncertainty aware mobile sensing and health applications and apply them to provide real-world robustness against distributional shifts and adversarial attacks.

She received her BEng and MEng in Computer Engineering from the University of Bologna and worked as a Software Engineer at various UK startups.

---

Website: <https://www.cl.cam.ac.uk/~lq223/>

Linkedin: <https://www.linkedin.com/in/lorena-q-54592684/>

Dr. Maurizio Bevilacqua

**The Data challenges: NPL's use cases on sensor data analysis, visualization, and validation**

Modern Data challenges such as: Sensor Data analysis, visualization, data organization, model fitting, and validation of calibrated output will be the core of the presentation showing different projects that Data Science at NPL has been working on the past few years.

As the UK metrology institute, we base our work focusing on uncertainty, data interpretation, and trustworthiness, furthermore we apply FAIR principles on our sensor data processes. Those aspects will be shown during the presentation of projects in health and medical context but also outcome of projects on sensors characterization for autonomous vehicle simulation.

---



Maurizio Bevilacqua is a Senior Research Engineer for the Informatic group in Data science at NPL, and for the past two years was involved in project for Data management, Digital Calibration certificate, and he is the Technical Leader for the informatic group on projects under the Assurance autonomy framework. Maurizio holds a PhD in Information Engineering from Salerno University in Italy, focusing primarily on contactless measurement systems, instrumentation, and automation.

He joined Cranfield University in 2014 as Postdoc, and he had experience working on National (EPSRC) and International (Horizon2020 and Bill & Melinda Gates foundation) research projects on wireless sensors network systems.

Leaving academia, Maurizio had acquired relevant experience in automotive consultancy working on modelling, testing and simulation of optical systems such as Lidars and camera for the realization of ADAS application within a driving simulator. Most recently, he worked as Vision Expert at former L3Harris, now Leidos.

---

Website: [Maurizio Bevilacqua - Senior Research Scientist - National Physical Laboratory \(NPL\) | LinkedIn](#)

Dr. Simon Tilley

### Seeing is believing

Sensor technology provides the opportunity to extend our horizons across many dimensions. How do we have confidence in what we see and make intelligent decisions or augment expert decision making with a true reflection of what's happening out there in the real world?

In consuming the avalanche of digital data we also need to ensure that we are accommodating biases that exist in the data and compensating to ensure that we create fair models that represent reality.

Understanding uncertainty in these data and will become a key competence in ensuring the enduring value of artificial intelligence. In the end, the successful use of sensors will be entirely dependent on the perceived legitimacy of the derived understanding and the actions taken as result.



---

Simon has spent over 30 years in the software industry and has worked in Europe, the US, the Middle East and the Far East across every aspect of a software business – from R&D, through Marketing and to Sales. Simon currently leads Product Management for the Healthcare and Life Science industries in R&D in the software company, SAS. SAS was founded in 1976 and was the original Advanced Analytics company. Whilst the underlying hardware has changed – SAS' objective remains the same – to make sense of data. To enable people to see beyond what the data look like and understand how they really work.

---

Website: [www.sas.com](http://www.sas.com)

Dr. John Kupiec

### **Environment Agency - Sensors: Applications, Developments and Challenges**

The Environment Agency's overall mission is to create better places for people and wildlife, and support sustainable development. Within England we're responsible for building & maintaining flood defences; managing national flooding emergencies; regulating major industries and managing the nation's water resources in terms of quality and quantity.

We are also responsible for the conservation of a range of habitats and species. We need to know both the state of the environment (air, land and water) and the underlying science so we can develop policies and practical interventions to make improvements - and assess their impact. Much of the information we need for this has its origins in the data generated by a sensing device. This presentation looks across the range of sensors that the Environment Agency uses and details some the main applications, future developments we are working on and challenges we face.



---

John Kupiec is the Innovation Manager at Environment Agency. This role in the Chief Scientist's Group is to identify innovative technologies and practices and assess how the Environment Agency can benefit from the use of new ideas, emerging technologies and better ways of working. The Environment Agency undertakes extensive monitoring of the environment and there has been a focus on the innovative use of remote sensing and in-situ sensing methods to gather data for policy development, environmental management and enforcement of regulations. Previously, John worked for Scottish Natural Heritage (the government agency responsible for conservation in Scotland) developing environmental monitoring systems to report on the state of the environment – particularly for Sites of Special Scientific Interest (SSSI's) and other statutory protected areas. John gained a PhD in Earth Observation working on a joint NERC/NASA project. This investigated the potential of a novel sensing instrument – NASA's Airborne Visible/Infra-Red Imaging Spectrometer (AVIRIS – mounted on a U2 aircraft) to estimate forest canopy metrics for input to carbon and ecosystem simulation models.

---

Website: [Environment Agency - GOV.UK \(www.gov.uk\)](http://www.gov.uk)

## Student talk abstracts

### Towards Uncertainty-Aware Murmur Detection in Heart Sounds via Tandem Learning

Erika Bondareva, Tong Xia, Jing Han, Cecilia Mascolo

Auscultation, the process of using a stethoscope for diagnostics, is a challenging task for medical professionals and requires years of training. As a result, the field of automated auscultation has been growing in popularity in the past decade. Previous efforts in the field focused on achieving high accuracy, with confident, albeit sometimes wrong, classifiers. Such model over-confidence is especially dangerous in healthcare setting. Leveraging the release of the new heart sound dataset as a part of PhysioNet 2022 challenge, we explored a novel murmur detection methodology using uncertainty-aware tandem learning. In order to effectively separate unknown samples and detect heart sounds with murmur present, we developed two binary classifiers, under the assumption that training two models to solve simpler tasks could improve the overall sensitivity. First, a support vector machine used spectral features for identification of unknown samples. We then used a Deep Neural Network (DNN) with a set of hand-crafted audio features for prediction of murmur. In addition, we implemented uncertainty estimation in DNN using Monte Carlo dropouts for further eliminating any samples that should be labelled as unknown. With our approach, while achieving 63% sensitivity and 69% and specificity of murmur, we also hope to bring the community a step closer towards explainable and trustworthy artificial intelligence, capable of admitting its lack of confidence in unclear cases.

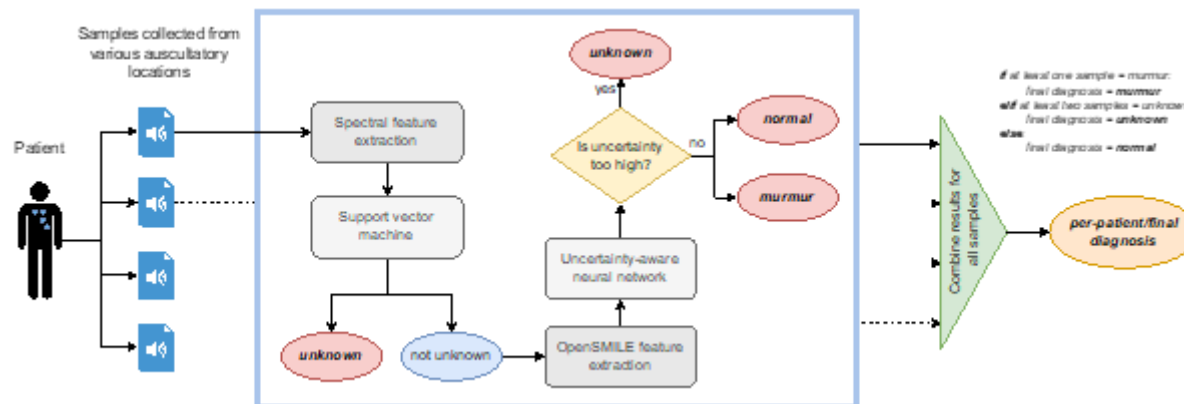

## Structural Mass Spectrometry Techniques for Investigating Therapeutic Peptides

**Gibson, Katie**<sup>1,3</sup>, Cooper-Shepherd, Dale.A.<sup>2</sup>, Pallister, Edward<sup>3</sup>, Inman, Sophie. E.<sup>3</sup>, Lindo, Viv<sup>3</sup> and Jackson, Sophie E.<sup>1</sup>.

<sup>1</sup>Yusuf Hamied Department of Chemistry, University of Cambridge, Cambridge, CB2 1EW, U.K.

<sup>2</sup>Waters Corporation, Wilmslow, SK9 4AX, U.K.

<sup>3</sup>Analytical Sciences, BioPharmaceuticals Development, R&D, AstraZeneca, Cambridge, U.K

Many peptide scaffolds for Diabetes Mellitus treatment <sup>1</sup> are based on the naturally occurring Glucagon-Like Peptide-1 (GLP-1) with a number of lipidated analogues. <sup>2</sup> However, the relationship between physical stability and batch (for a range of peptides not just GLP-1) can be influenced by many things, for example trace impurities or specific purification processes. The lack of techniques with sufficient resolution for detailed characterisation of batches limits the depth to which we understand reasons for batch variation. Structural mass spectrometry (MS) techniques are advanced, high resolution, sensitive methods that further our understanding of the physical stability of GLP-1-like peptides, their potential impurities and batch variation. This talk focuses on two case studies detailing how Ion Mobility-MS identified and differentiated regio-isomers of a potential isoAspartic acid impurity in a lipidated peptide, <sup>3</sup> and how millisecond Hydrogen Deuterium Exchange-MS <sup>4</sup> is being developed to investigate structural differences between purification batches of a different GLP-1-like peptide.

### Case Study 1: Ion Mobility Mass Spectrometry

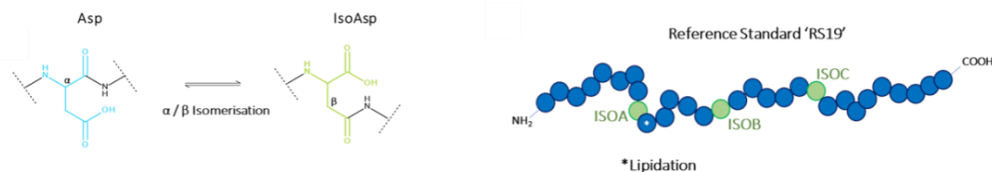

Reprinted from K. Gibson, D. A. Cooper-Shepherd, E. G. Pallister, S. E. Inman, S.E. Jackson and V. Lindo, JASMS, 2022, 33, 7, 1204-1212 (<https://pubs.acs.org/doi/full/10.1021/jasms.2c00053>) further permissions to be directed to the ACS

### Case Study 2: Fast Hydrogen Deuterium Exchange Mass Spectrometry

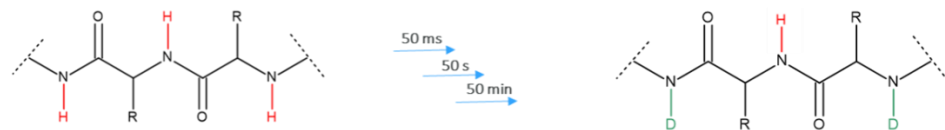

## Sensor Measurement Uncertainty and Ways to Reduce it

James T. Meech\* and Phillip Stanley-Marbell

We present thermal-chamber measurements of the sensor noise of five widely available commercial sensors at constant temperature. These sensors measure six different physical quantities including temperature, pressure, humidity, acceleration, magnetic field, and angular rate. We placed an embedded system containing the sensor on a vibration isolation stage to damp out any vibration that would confound the measurements. Figure 1 shows the kurtosis, skewness and raw histograms of 10,000 value stationary distributions for each sensor [1].

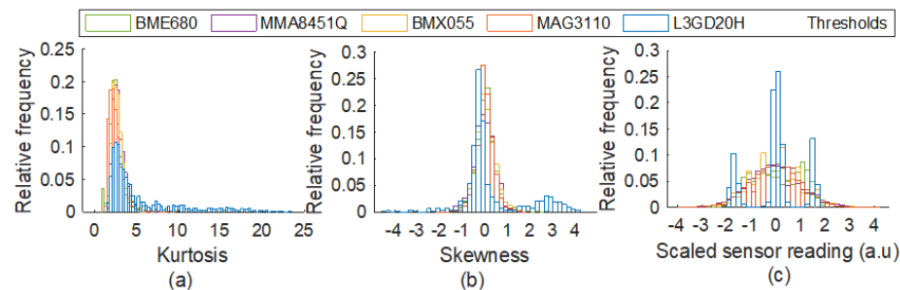

Figure 1. Histograms of the kurtosis (a) and skewness (b) of 333 thirty-sample distributions from all axes physical quantities measured by each sensor compacted into one histogram per sensor. (c) Histogram of 10,000 sample stationary distributions of the inertial sensor z-axes and the BME680 pressure scaled to fit them in the same domain.

We present an algorithm for reducing measurement uncertainty of one physical quantity when given oversampled measurements of two physical quantities with correlated noise. The algorithm assumes that the aleatoric measurement uncertainty in both physical quantities follows a Gaussian distribution and relies on sampling faster than it is possible for the measurand (the true value of the physical quantity that we are trying to measure) to change (due to the system thermal time constant) to calculate the parameters of the noise distribution. In contrast to the Kalman and particle filters, which respectively require state update equations and a map of one physical quality, our algorithm requires only the oversampled sensor measurements. When applied to temperature-compensated humidity sensors, it provides reduced uncertainty in humidity estimates from correlated temperature and humidity measurements. In an experimental evaluation, the algorithm achieves average uncertainty reduction of 10.3 %. The algorithm incurs an execution time overhead of 5.3 % when compared to the minimum algorithm required to measure and calculate the uncertainty. Detailed instruction-level emulation of a C-language implementation compiled to the RISC-V architecture shows that the uncertainty reduction program required 0.05 % more instructions per iteration than the minimum operations required to calculate the uncertainty.

References [1] J. T. Meech and P. Stanley-Marbell, "An Algorithm for Sensor Data Uncertainty Quantification", in *IEEE Sensors Letters*, vol. 6, no. 1, pp. 1-4, Jan. 2022, Art no. 7000204, doi: 10.1109/LSENS.2021.3133761.

## Optofluidic Hollow-Core Photonic Crystal Fibres as Label-Free Biophysical Sensors

Presenting author: Jan Heck

Proteins are the central building blocks of life, and protein sensors have to work with challengingly small sample volumes at low concentrations.<sup>[1]</sup> In our recent work<sup>[2]</sup>, we demonstrate continuous-flow microfluidic measurements on native (label-free) serum proteins in  $\mu\text{L}$  detection volumes. By comparison, current approaches rely on fluorescent labels and stains. Unfortunately, recent research shows they alter protein behaviour, and their incorporation adds process complexity.<sup>[3]</sup> Instead, we use hollow-core photonic crystal fibres (HC-PCFs) as microfluidic biophysical sensors that detect label-free proteins' intrinsic ultraviolet fluorescence. HC-PCFs surround a microfluidic channel with a sub-micron glass microstructure that confines light by anti-resonant reflection.<sup>[4]</sup> The resulting "optofluidic" waveguides uniquely enable long optical pathlengths (and thus increased detection sensitivity), with sample volumes well below  $1 \mu\text{L}$ , and allowing in-line integration with existing microfluidic circuits.

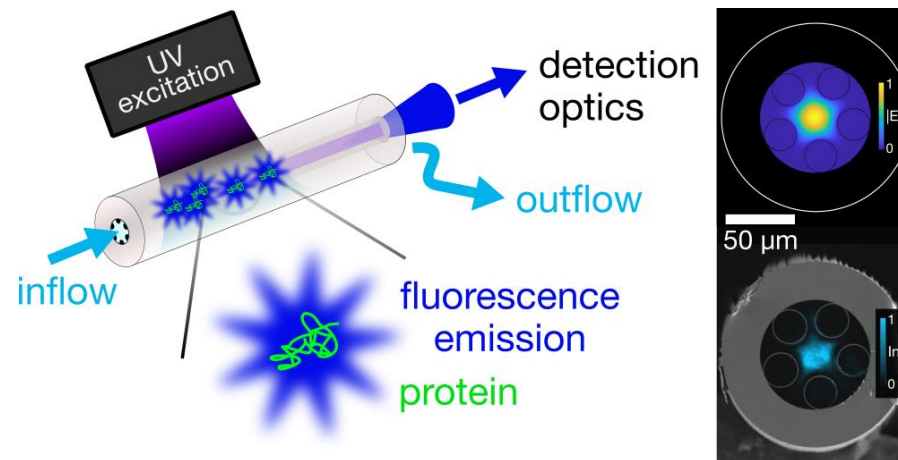

- [1] Protein Fluorescence. In *Principles of Fluorescence Spectroscopy*; Lakowicz, J. R., Ed.; Springer US: Boston, MA, 2006; pp 529–575. [https://doi.org/10.1007/978-0-387-46312-4\\_16](https://doi.org/10.1007/978-0-387-46312-4_16).
- [2] Heck, J. R.; Miele, E.; Mouthaan, R. P.; Frosz, M. H.; Knowles, T. P. J.; Euser, T. G. Label-Free Monitoring of Proteins in Optofluidic Hollow-Core Photonic Crystal Fibres. *Methods Appl. Fluoresc.*, **2022**. <https://doi.org/10.1088/2050-6120/ac9113>.
- [3] Saar, K.-L.; Yates, E. V.; Müller, T.; Saunier, S.; Dobson, C. M.; Knowles, T. P. J. Automated Ex Situ Assays of Amyloid Formation on a Microfluidic Platform. *Biophysical Journal*, **2016**, *110* (3), 555–560. <https://doi.org/10.1016/j.bpj.2015.11.3523>.
- [4] Cubillas, A. M.; Unterkofler, S.; Euser, T. G.; Etzold, B. J. M.; Jones, A. C.; Sadler, P. J.; Wasserscheid, P.; Russell, P. St. J. Photonic Crystal Fibres for Chemical Sensing and Photochemistry. *Chem. Soc. Rev.*, **2013**, *42* (22), 8629. <https://doi.org/10.1039/c3cs60128e>.



## Intracellular A $\beta$ 42 aggregation leads to cellular thermogenesis

Chyi Wei Chung<sup>1</sup>, Amberley D. Stephens<sup>1</sup>, Tasuku Konno<sup>2</sup>, Edward Ward<sup>1</sup>, Edward Avezov<sup>2</sup>, Clemens F. Kaminski<sup>1</sup>, Ali A. Hassanali<sup>3</sup>, Gabriele S. Kaminski Schierle<sup>1\*</sup>

<sup>1</sup> Department of Chemical Engineering and Biotechnology, University of Cambridge, CB3 0AS, UK

<sup>2</sup> UK Dementia Research Institute, University of Cambridge, CB2 0AH, UK

<sup>3</sup> Condensed Matter & Statistical Physics, International Centre for Theoretical Physics, Trieste 34151, Italy

The aggregation of A $\beta$ 42 is a hallmark of Alzheimer's disease. It is still not known what biochemical changes inside a cell eventually lead to A $\beta$ 42 aggregation. We perform intracellular thermometry showing that A $\beta$ 42 aggregation in live cells leads to increased cell-averaged temperatures. This rise is mitigated upon treatment with an A $\beta$ 42 aggregation inhibitor. Hence, we present a diagnostic assay which could be used to screen small-molecule inhibitors to amyloid proteins in physiologically-relevant settings. To interpret our experimental observations and motivate the development of future models, we perform classical molecular dynamics simulations on A $\beta$  peptides to examine the factors that hinder thermal dissipation, e.g., ionic interactions with terminal groups and the extent of hydrogen bonding with water. We show that aggregation and heat retention by A $\beta$  peptides are favoured under intracellular-mimicking conditions, which could potentially promote thermogenesis. The latter will, in turn, trigger further nucleation events that accelerate disease progression.

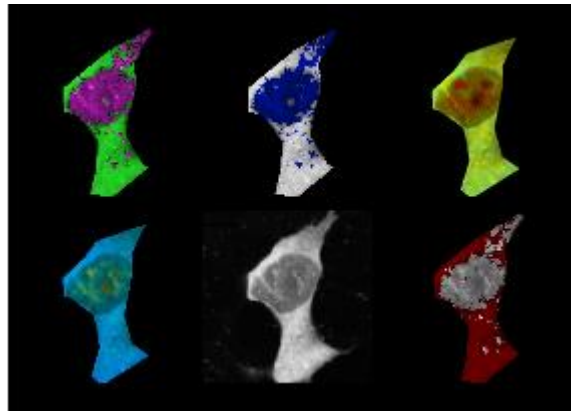

## Interactions between alpha-synuclein and lipid membranes in Parkinson's disease

Greta Musteikyte, Tuomas Knowles

Yusuf Hamied Department of Chemistry, Cambridge, University of Cambridge, CB3 0AS, UK

Parkinson's disease (PD) is an increasingly prevalent and currently incurable neurodegenerative disorder linked to the accumulation of aggregates of the protein  $\alpha$ -synuclein ( $\alpha$ S) in the nervous system. While  $\alpha$ S binding to membranes in its monomeric state is suggested to be crucial for its physiological role,  $\alpha$ S oligomerisation and subsequent aberrant interactions with lipid bilayers are emerging as key steps in PD-associated neurotoxicity. However, little is known about the mechanisms which define the interactions of oligomeric  $\alpha$ S (O $\alpha$ S) with lipid membranes and factors that modulate such interactions. This situation is in large part due to experimental challenges in studying O $\alpha$ S-membrane interactions. This challenge was addressed by using a suite of microfluidics-based assays that enable in-solution quantification of O $\alpha$ S-membrane interactions. It was found that O $\alpha$ S bind more strongly to highly curved, rather than flat, lipid membranes. By comparing the membrane-binding properties of O $\alpha$ S and monomeric  $\alpha$ S (M $\alpha$ S), it was further demonstrated that O $\alpha$ S bind to membranes with up to 150-fold higher affinity than their monomeric counterparts. Moreover, O $\alpha$ S compete with and displace M $\alpha$ S from the membrane surface, suggesting that disruptions to the functional binding of M $\alpha$ S to membranes may provide an additional toxicity mechanism in PD. These findings present a unique binding mechanism of oligomers to membranes which can be potentially targeted to inhibit the progression of PD.

## Studying Organic Electrochemical Transistors for Applications in Neuroscience Diagnostics

Stefany Kissovsky, Professor Gabriele Kaminski Schierle (CEB), Professor George Malliaras (Electrical Engineering Division), *University of Cambridge*

Alzheimer's is a progressive disease, which affects more than 50 million people worldwide and is expected to affect three times more people by 2050 [1]. Although Alzheimer's disease is related to the misregulation of two biomarkers in the brain: the amyloid-beta ( $A\beta$ ) and Tau protein (*p-tau181*), its cause and means of progression remain unknown. Recent studies show that dysfunction in cholesterol metabolism in the central nervous system is directly correlated with amyloid-beta production and tau aggregation [2], [3]. Organic electrochemical transistors (OECTs) were fabricated with poly(3,4-ethylenedioxythiophene) polystyrene sulfonate (PEDOT:PSS) channel and were biofunctionalised to investigate their ability to detect super low brain cholesterol concentrations and correlate those concentrations to the pathogenesis of Alzheimer's disease. OECTs have proven to be promising and highly effective biosensors due to their amplification properties, stability in aqueous media and biocompatibility [4]. Upon characterisation with a semiconductor parameter analyser, OECTs have shown the ability to detect as low as nanomolar analyte concentrations and be responsive to varying cholesterol concentrations. Thus, OECTs will provide a novel method for a fast and user-friendly quantification of brain cholesterol, leading to better understanding of the role of cholesterol metabolism in AD's pathology.

Figure 1: OECT design, biofunctionalisation of the gate electrode, and circuitry

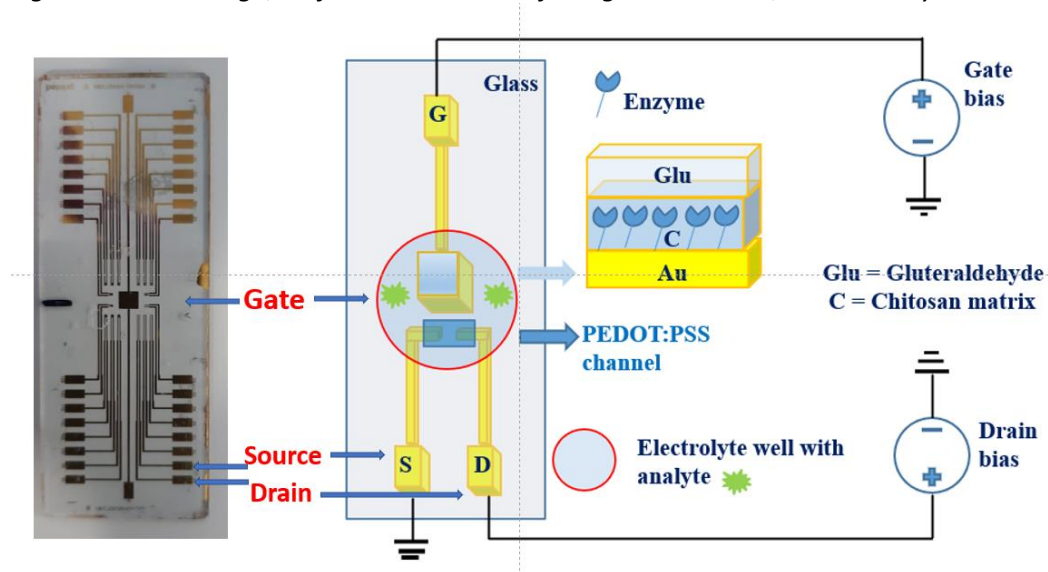

### References:

- [1] Naomi A Fineberg et al. "The size, burden and cost of disorders of the brain in the UK". In: *Journal of Psychopharmacology* 27.9 (2013), pp. 761–770. doi: 10.1177/0269881113495118.
- [2] Juan Zhang and Qiang Liu. "Cholesterol metabolism and homeostasis in the brain". In: *Protein amp; Cell* 6.4 (2015), pp. 254–264. doi: 10.1007/s13238-014-0131-3.
- [3] Lijun Dai et al. "Cholesterol metabolism in neurodegenerative diseases: Molecular mechanisms and therapeutic targets". In: *Molecular Neurobiology* 58.5 (2021), pp. 2183–2201. doi: 10.1007/s12035-020-02232-6.
- [4] Liming Bai et al. "Biological Applications of Organic Electrochemical Transistors: Electrochemical Biosensors and Electrophysiology Recording". In: *Frontiers in Chemistry* 7 (2019). doi: 10.3389/fchem.2019.00313

## About the Sensors CDT

The **EPSRC Centre for Doctoral Training in Sensor Technologies for a Healthy and Sustainable Future** (Sensor CDT) delivers an interdisciplinary and research focussed training programme to students who have the aspiration as well as the academic and technical skills to become world leaders in the field of sensors.

Students are taught and supervised by academics and researchers from around 20 departments across the University of Cambridge. This allows them to sample a broad variety of research environments and gain hands-on experience in the use and capabilities of state-of-the-art research instruments and techniques. The first year of the Sensor CDT programme is an MRes course, consisting of a balanced mix of taught and research components. Lectures introduce our students to the science that underpins sensor design and applications. Research projects and a team challenge provide key skills to carry out cutting edge sensor research in experimental design, project management, data handling, dissemination of research outcomes and teamwork. This is followed by three years of PhD research during which the students continue to learn from leading experts and each other during our monthly Sensors Café workshops and seminars.

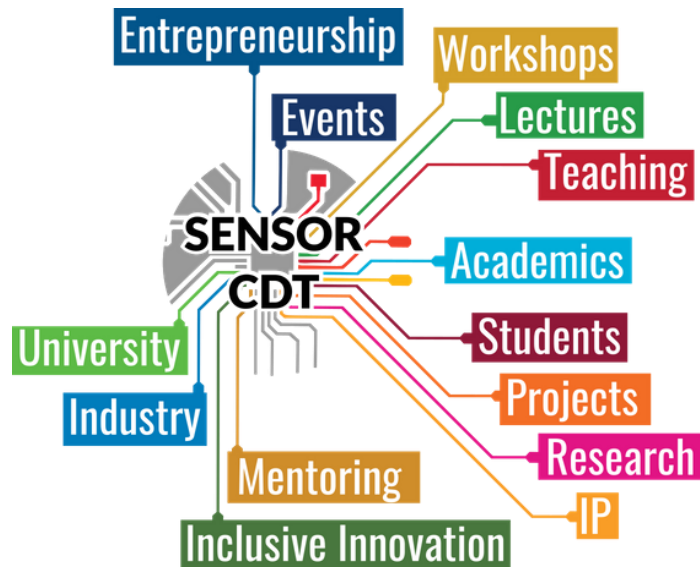

<https://cdt.sensors.cam.ac.uk/>



## Sponsors



A special thanks to Zimmer&Peacock for sponsoring our student talk prizes!

